

Melbourne City
Council Offices
(CH2)

Chilled Panel Ceiling Configuration Report

Prepared for:
Melbourne City Council

Prepared by:
Advanced Environmental
Concepts Pty Ltd
ACN 075 117 243
Level 1, 41 McLaren Street
North Sydney NSW 2060

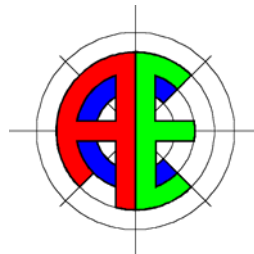

design advice

passive systems

design analysis

low energy services

March 03

AESY820000\0\2\EKA30304

EXECUTIVE SUMMARY

The main purpose of this report is to investigate various options proposed for the location of the chilled panels on the curved soffit within the new Melbourne City Council offices. Each chilled panel location option is to be considered with respect to:

- Air flows
- Air Temperature
- Mean Radiant Temperatures
- Resultant temperatures
- Occupant Comfort Levels

Two options were considered: Option 1 which incorporated the chilled panel as a continuous panel across the lowest portion of the curved ceiling and Option 2 which incorporated the chilled panel to sit in separate parts on the sloped portion of the curved ceiling.

The model results indicated that the chilled panel position in Option 2 is the preferred option for the development due to the superior thermal performance results, particularly air flow and air temperature.

TABLE OF CONTENTS

EXECUTIVE SUMMARY	I
TABLE OF CONTENTS	II
LIST OF FIGURES	III
1 INTRODUCTION	1
2 APPROACH	2
2.1 Computer Modelling	2
2.2 Mechanical System	2
2.3 Design Inputs	2
2.4 Air flows	3
2.5 Air Temperature	3
2.6 Mean Radiant Temperatures	3
2.7 Resultant Temperatures	3
2.8 Occupant Comfort Levels	3
3 DESIGN CONCEPTS	4
3.1 Options	4
4 RESULTS	6
4.1 Air flows	6
4.2 Air Temperature	8
4.3 Mean Radiant Temperatures	10
4.4 Resultant Temperatures	11
4.5 Occupant Comfort Levels (Predicted Percentage Dissatisfied)	12
4.6 Option 2 Revised Relief Air Outlet Results	13
5 CONCLUSION/RECOMMENDATIONS	14

APPENDIX A

Date		
Revision and Status		
Author		
Project Team Leader		

LIST OF FIGURES

Figure 1: Option 1 Chilled panel on lowest portion of ceiling	4
Figure 2: Model of Option 1	4
Figure 3: Option 2 Chilled panel on sloped portion of ceiling	5
Figure 4: Model of Option2.....	5
Figure 5: Option1 Air Flow Pattern	6
Figure 6: Option 2 Air Flow Pattern	6
Figure 7: Option 1 Air Temperatures.....	8
Figure 8: Option 2 Air Temperatures.....	8
Figure 9: Option 1 Mean Radiant Temperature.....	10
Figure 10: Option 2 Mean Radiant Temperature.....	10
Figure 11: Option 1 Resultant Temperature	11
Figure 12: Option 2 Resultant Temperature	11
Figure 13: Option 1 PPD	12
Figure 14: Option 2 PPD	12
Figure 15: Option 2 Revised Relief Air Outlet Model.....	16
Figure 16: Option 2 Revised Relief Air Outlet Air Flow Pattern	16
Figure 17: Option 2 Revised Relief Air Outlet Air Temperature	17
Figure 18: Option 2 Revised Relief Air Outlet Mean Radiant Temperature	17
Figure 19: Option 2 Revised Relief Air Outlet Resultant Temperature	18
Figure 20: Option 2 Revised Relief Air Outlet PPD	18

1 INTRODUCTION

One of the design objectives of the Melbourne City Council development is to create a working environment with improved indoor air quality, improved ventilation efficiency and improved thermal comfort when compared to a typical office building, whilst being low in energy consumption.

The Melbourne City Council Development is to incorporate a unique wave pattern ceiling within the office spaces. The ceiling will be a visual focus point of the office space and consequently the co-ordination of the services on the ceiling is important not only from a thermal performance perspective, but also aesthetically.

The main purpose of this report is to investigate various options proposed for the location of the chilled panels on the curved ceiling within the Melbourne City Council development. Each chilled panel location option is to be considered with respect to:

- Air flows
- Air Temperature
- Mean Radiant Temperatures
- Resultant temperatures
- Occupant Comfort Levels

Recommendations made within this report are to assist the design team in the ceiling co-ordination of services.

2 APPROACH

2.1 Computer Modelling

The systems proposed were modelled using a computational fluid dynamics (CFD) 'Ambiens" program created for analysing building microclimates. Ambiens simulates the air flow and temperature across a two-dimensional building space by repeatedly solving a set of equations that represent the flow and temperature, until the results approach an accurate solution.

2.2 Mechanical System

The following mechanical system was modelled:

Supply air is distributed to the office floor via a displacement system. The displacement system is 100% outside air supplied to the office space from a floor plenum via displacement diffusers.

Relief air from each floor will be exhausted passively via ceiling mounted relief air grilles.

Supplementing the displacement system is a combination of chilled beams and ceiling panels. Chilled beams are located above vision panels around the perimeter to cater for varying solar and transmission loads. Chilled ceiling panels are located throughout the space and will cater for the total internal space loads.

For this investigation we have modelled an internal space within the office, thus the displacement ventilation system is modelled in conjunction with chilled ceiling panels.

2.3 Design Inputs

Mechanical System	
Chilled Ceiling Panel Radiant Temperature	18degC
Displacement System Supply Air Temperature	20degC
Displacement System Supply Air Quantity	1.5l/s/m ²
Internal Loads	
Occupancy	1person/15m ²
Occupant Load	70W Sens/ 70W Lat
Lighting Load	23W per fitting
Equipment Load	11.5 W/m ²
Occupant Comfort	
Metabolic Rate	1
Clothing Type	Shirt and trousers

2.4 Air flows

The main issue to consider in the application of displacement ventilation is the management of air velocities and temperatures immediately adjacent people. This is often referred to as the 'near zone' or 'occupied zone' and requires special consideration in calculation methodologies. It is imperative to providing adequate thermal comfort that the frequency and locations of supply and return air outlets are reviewed to ensure that supply air is distributed evenly throughout the space.

Displacement ventilation works on the principal that cool air is supplied from low level at a low velocity in the vicinity of occupants. As the air gains heat from occupants and equipment the air rises within the space to where it is typically relieved at high level. The addition of a cold radiant surface at high level, such as a chilled panel, provides an opportunity for the air to be re-cooled. This cooling effect on the air may result in cooler air 'dumping' back on to occupants. Air draughts have a very detrimental effect on the thermal comfort of an occupant.

Each chilled panel option will be reviewed for air flow patterns to ensure optimum air distribution throughout the floor.

2.5 Air Temperature

To maintain occupant comfort within a space it is important that the area occupied by a person is maintained at a comfortable temperature. Displacement systems aim to create a comfortable environment within the occupied zone rather than the whole space. An air temperature upper limit of 25 degC and a lower limit of 21 degC have been identified as the design criteria for the office floors.

Each chilled panel option will be reviewed for space air temperature patterns to ensure the occupied zone is maintained at consistent levels.

2.6 Mean Radiant Temperatures

People's thermal comfort depends significantly on the radiation between them and their surroundings. The mean radiant temperature at a point within an enclosure is a function of areas, shapes, surface temperatures and emissivities of the enclosing elements viewed from that point.

Each chilled panel option will be reviewed for mean radiant temperature patterns.

2.7 Resultant Temperatures

A maximum resultant temperature of 23degC has been identified as the design criteria for the office floors. The resultant temperature considers both the air temperature and mean radiant temperatures. It is generally perceived as a more accurate indication of thermal comfort of occupants than air temperature alone.

Each chilled panel option will be reviewed for resultant temperature patterns to ensure that the occupied zone is maintained within the designed level.

2.8 Occupant Comfort Levels

The Ambiens software has a thermal comfort model incorporated within it which creates a Predicted Percentage Dissatisfied (PPD). The PPD takes into account physical activity, clothing, air temperature, mean radiant temperature, air velocity and humidity. Generally a dissatisfaction of fewer than 15% is aimed for in offices. Each chilled panel option will be reviewed for PPD.

3 DESIGN CONCEPTS

3.1 Options

Preliminary calculations indicate that the chilled ceiling panels are to cover 35% of the curved ceiling. Various options have been proposed for the location of the chilled panels with the following two options being identified as being the most viable with respect to thermal comfort and aesthetics.

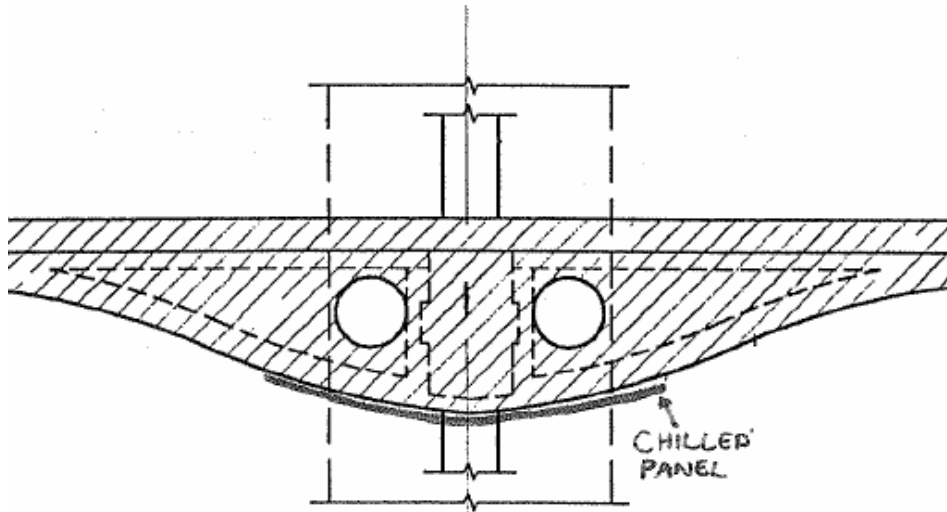

Figure 1: Option 1 Chilled panel on lowest portion of ceiling

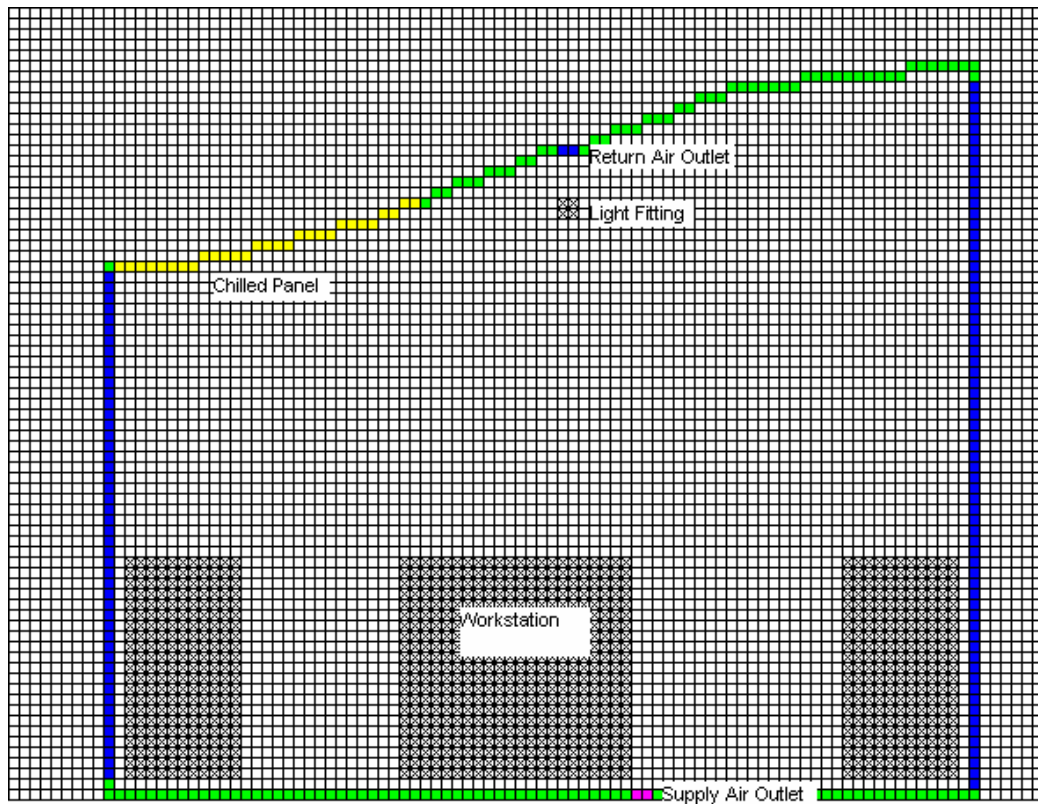

Figure 2: Model of Option 1.

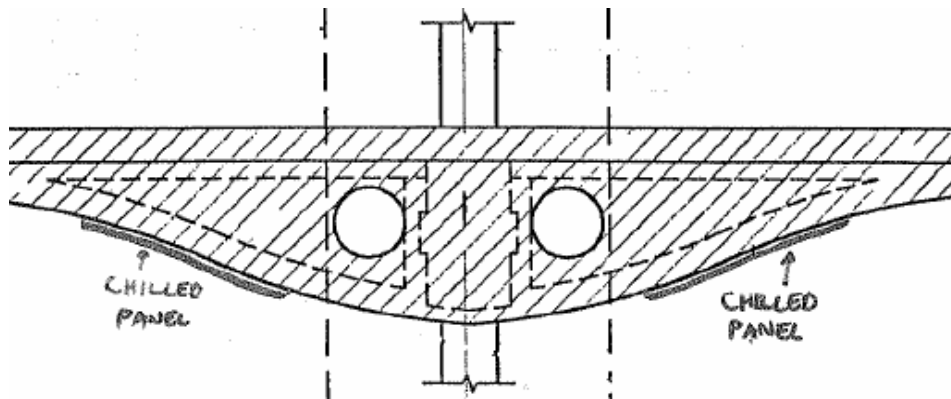

Figure 3: Option 2 Chilled panel on sloped portion of ceiling

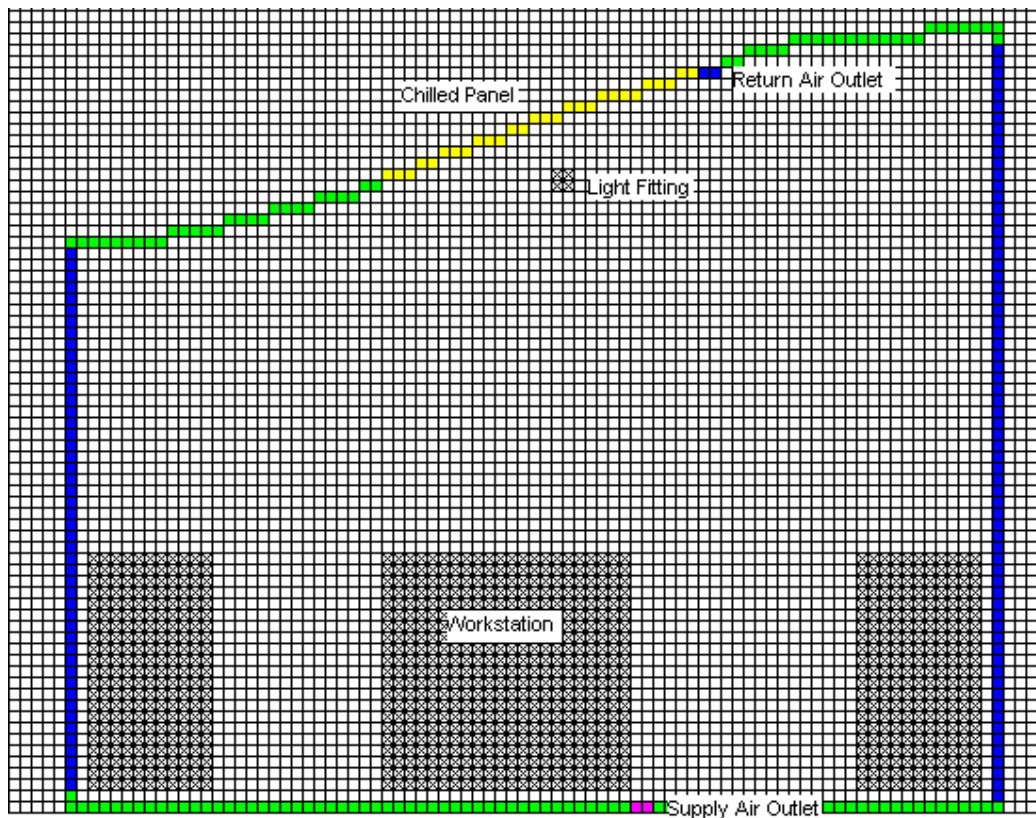

Figure 4: Model of Option2

As detailed in the above figures, each option is modelled as a half-bay section (4.1m wide) incorporating a hanging lighting fitting, a return air grille in the ceiling space and a floor supply air diffuser adjacent to an area modelled as an occupied workstation.

4 RESULTS

4.1 Air flows

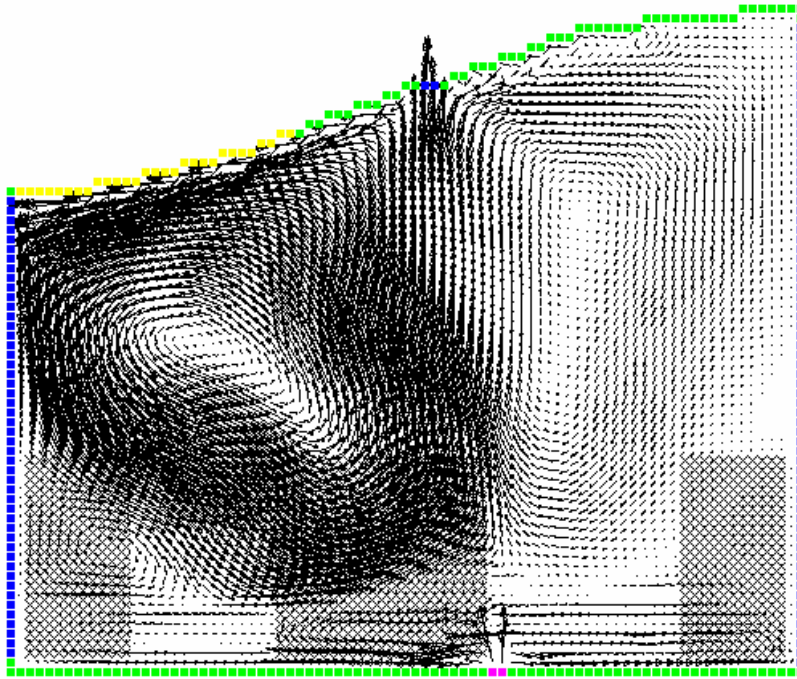

Figure 5: Option1 Air Flow Pattern

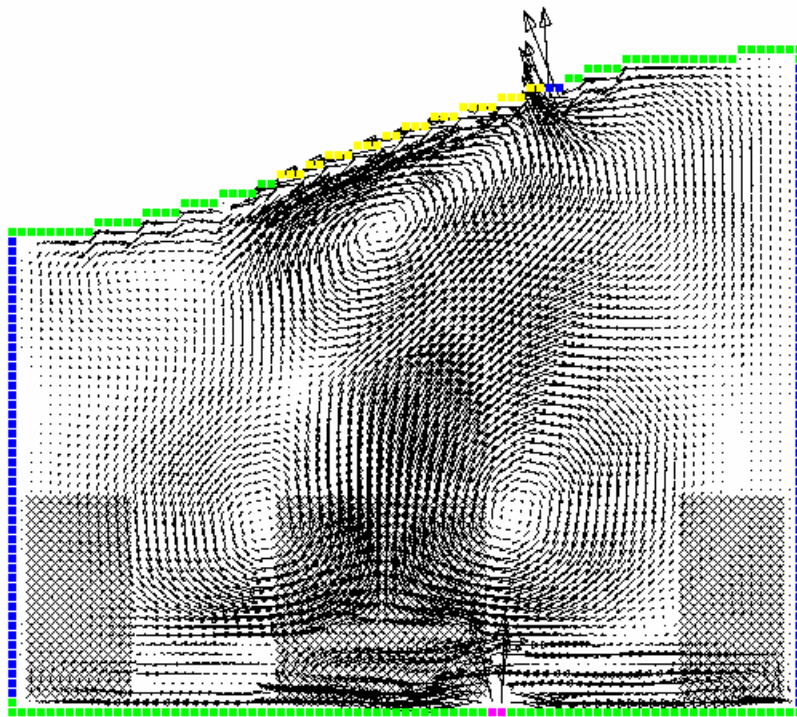

Figure 6: Option 2 Air Flow Pattern

The above results indicate that the lower chilled ceiling panels of Option 1 are creating a downward flow of air along the ceiling towards the lowest point of the curved ceiling. As air meets from both sides of the curved ceiling the air flows

converge and drop, creating a “dumping” effect which may produce down draughts. Down draughts will have a detrimental effect on an occupant's thermal comfort, despite air temperature, as they usually occur on the back of an occupant's neck which is an area known to be particularly sensitive to air movement.

The Option 2 air flow pattern is more uniform than Option 1, with consistent air velocities and even air distribution.

4.2 Air Temperature

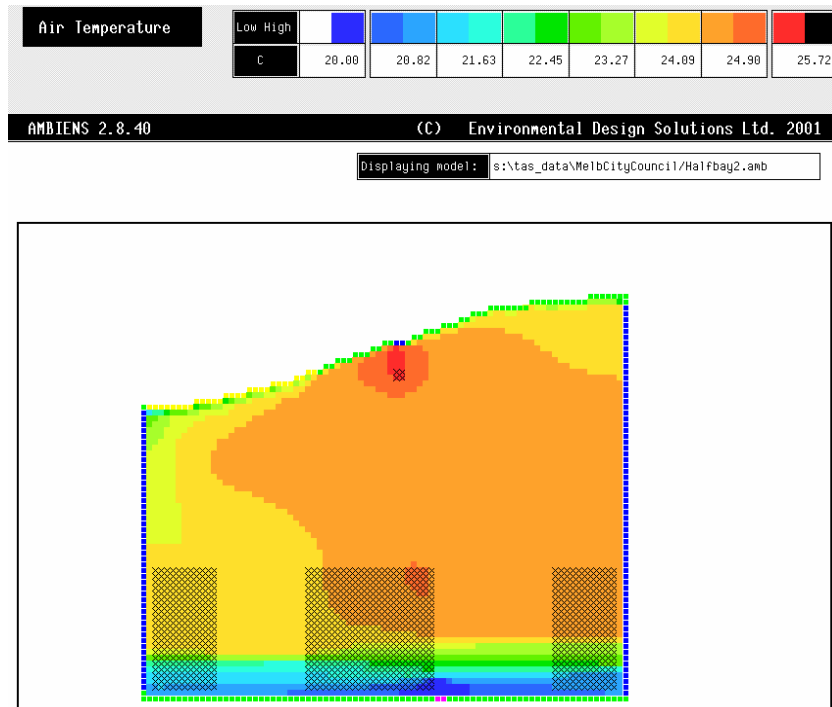

Figure 7: Option 1 Air Temperatures

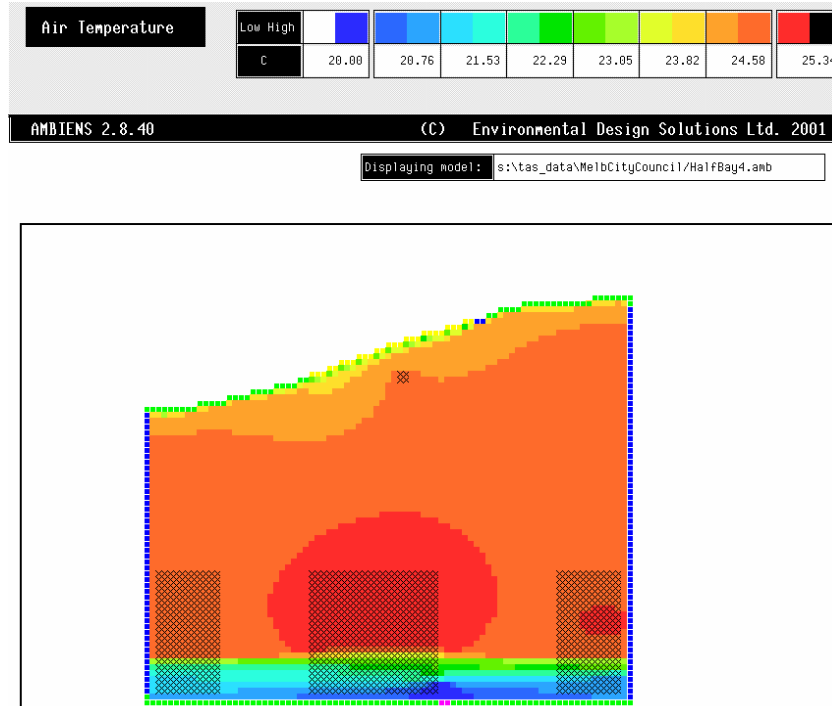

Figure 8: Option 2 Air Temperatures

The figures above illustrates that the lower ceiling position of the chilled panels in Option 1 contribute towards a lower air temperature directly below the chilled panels. The temperature increases as you move away from the vicinity of the panel. The occupied zone air temperature has a mixed gradient of temperatures.

Option 2, however, although having slightly higher temperatures, is evenly distributed across the office floor. The occupied zone has a somewhat higher temperature than the remaining office floor area, which is as expected for a displacement ventilation system.

4.3 Mean Radiant Temperatures

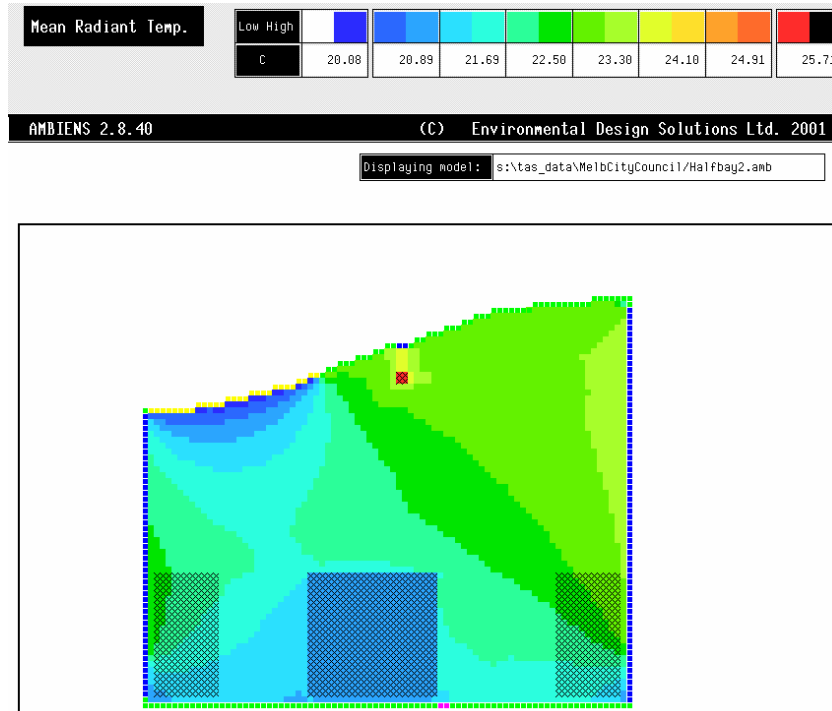

Figure 9: Option 1 Mean Radiant Temperature

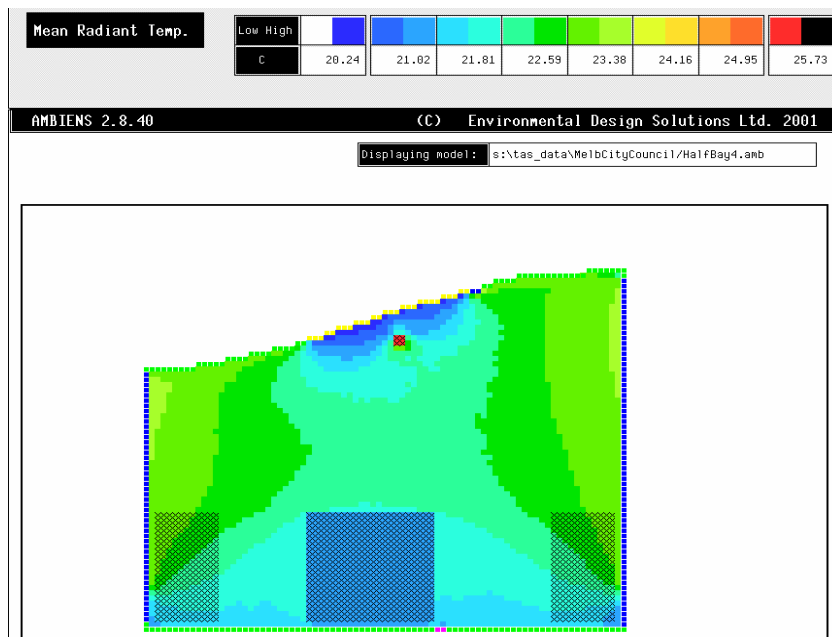

Figure 10: Option 2 Mean Radiant Temperature

From the above figures we note that the lower chilled panel position of Option 1 results in a lower mean radiant temperature extending to the occupied zone. The cooler radiant temperatures off the floor surfaces are the result of the floor surface temperature being low due to the supply air plenum below.

4.4 Resultant Temperatures

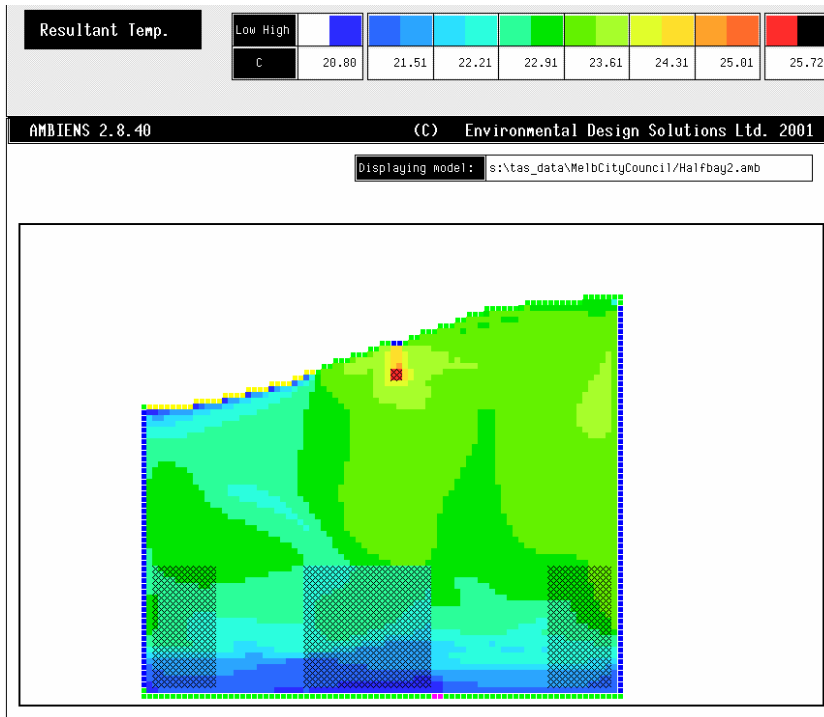

Figure 11: Option 1 Resultant Temperature

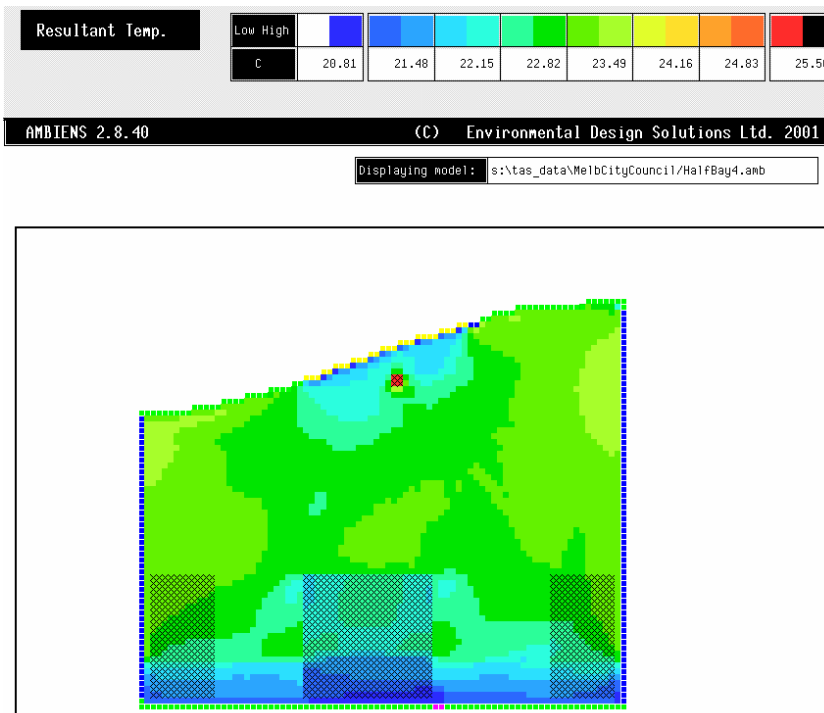

Figure 12: Option 2 Resultant Temperature

Option 1 indicates a lower resultant temperature below the chilled panel than Option 2. This would be due to the increased radiant effect of the chilled panel. Both options indicate similar resultant temperatures within the occupied zone.

4.5 Occupant Comfort Levels (Predicted Percentage Dissatisfied)

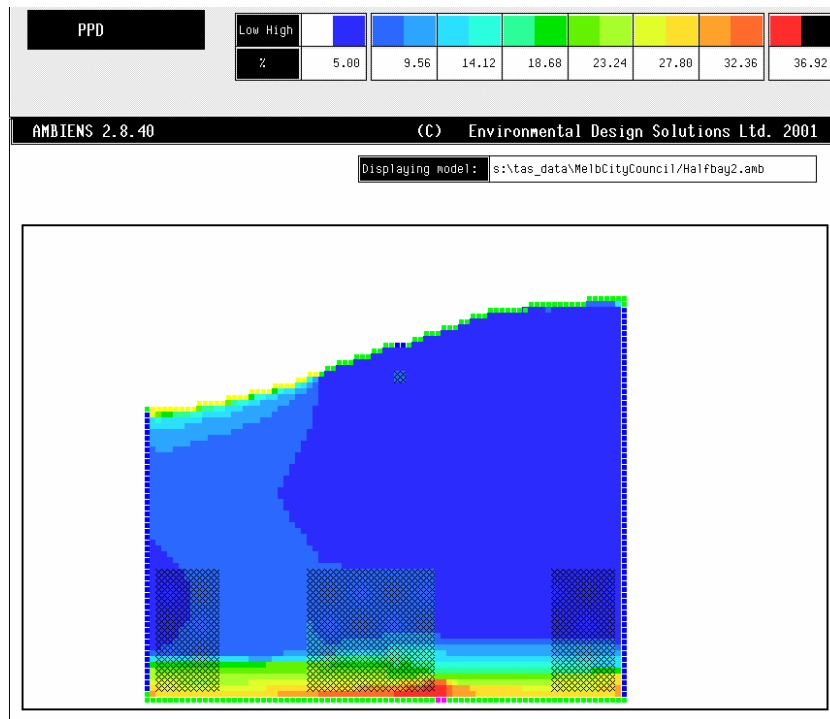

Figure 13: Option 1 PPD

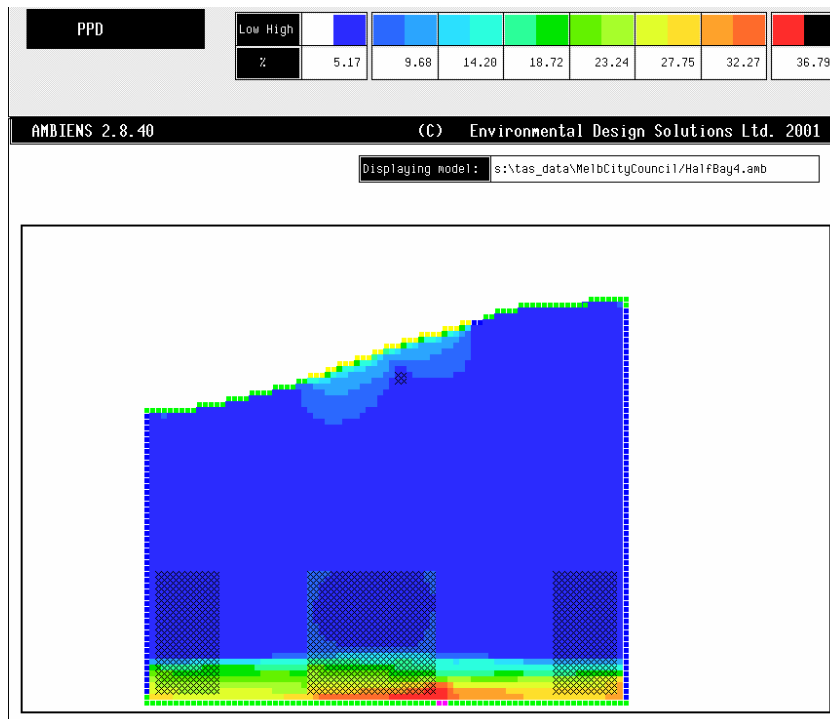

Figure 14: Option 2 PPD

Option 1 shows a higher PPD directly below the chilled panels than Option 2. Option 2 shows a consistently low PPD across the whole floor with an even lower percentage dissatisfied within the occupied zone.

4.6 Option 2 Revised Relief Air Outlet Results

Option 2 was remodelled with a revised relief air outlet position to determine whether the relief air outlet position had a significant effect on the air flows and thermal performance of the space. The results are contained within Appendix A.

The air flow patterns, mean radiant temperatures, resultant temperatures and PPD's are very similar for both relief air outlet positions, however the warmer air temperature zone within the occupied area is slightly larger for the lower positioned relief air grille.

5 CONCLUSION/RECOMMENDATIONS

Comparing the lower Chilled Panel position of Option 1 to the higher chilled panel position of Option 2 we obtained the following results:

- Option 2 has the superior air distribution of the two options with Option 1 potentially forming air draughts from the lowest point of the curved ceiling.
- Option 2 has a more uniform air temperature across the floor with a higher air temperature in the occupied zone. Option 1 has lower air temperatures below the chilled panel with a mixed gradient of air temperature across the office floor.
- Option 1 has a lower Mean Radiant Temperature below the chilled panel extending to the occupied zone. The lower Mean Radiant Temperature from Option 2's chilled panels does not extend to the occupied zone.
- Option 1 has a lower resultant temperature below the chilled panels than Option 2.
- Option 1 has a higher Percentage of People Dissatisfied (PPD) directly below the chilled panels than Option 2. Option 2 has a uniform PPD across the office floor with a lower PPD recorded in the occupied zone.

The above results indicate that the chilled panel position in Option 2 is the preferred option for the development due to the superior thermal performance results outlined above.

The results obtained from the investigation of relocating the relief air grille position in the Option 2 model did not result in any major changes to the Option 2 thermal comfort parameters. Subsequently it may be recommended that either relief air outlet position may be considered for the project.

APPENDIX A
OPTION 2 REVISED RELIEF AIR OUTLET RESULTS

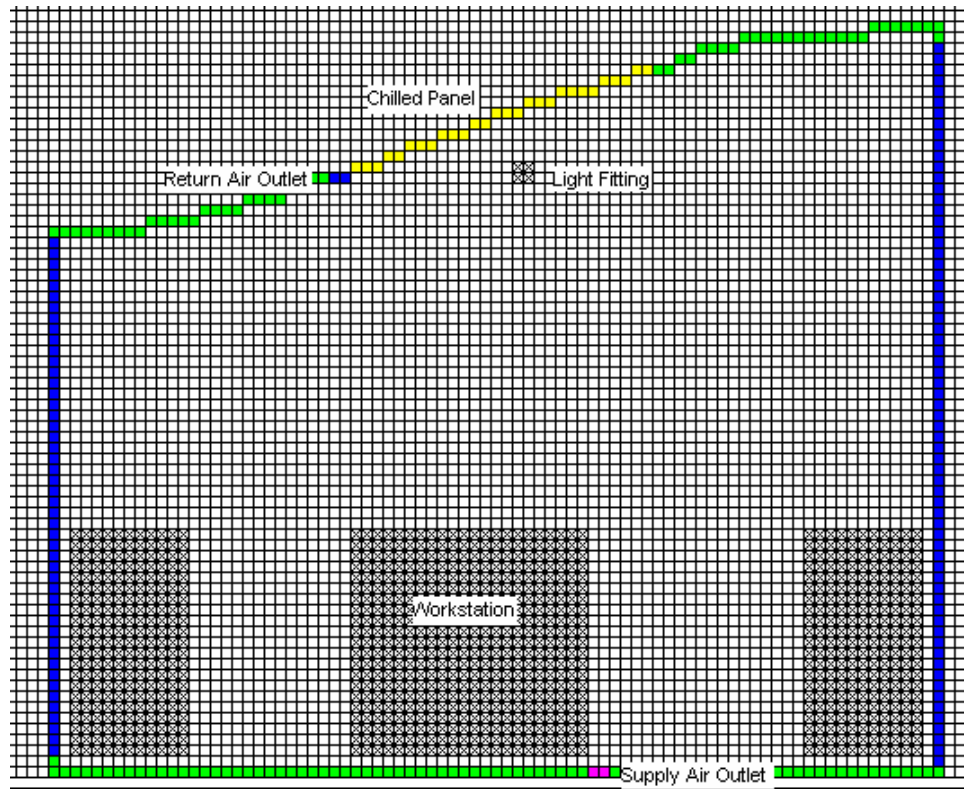

Figure 15: Option 2 Revised Relief Air Outlet Model

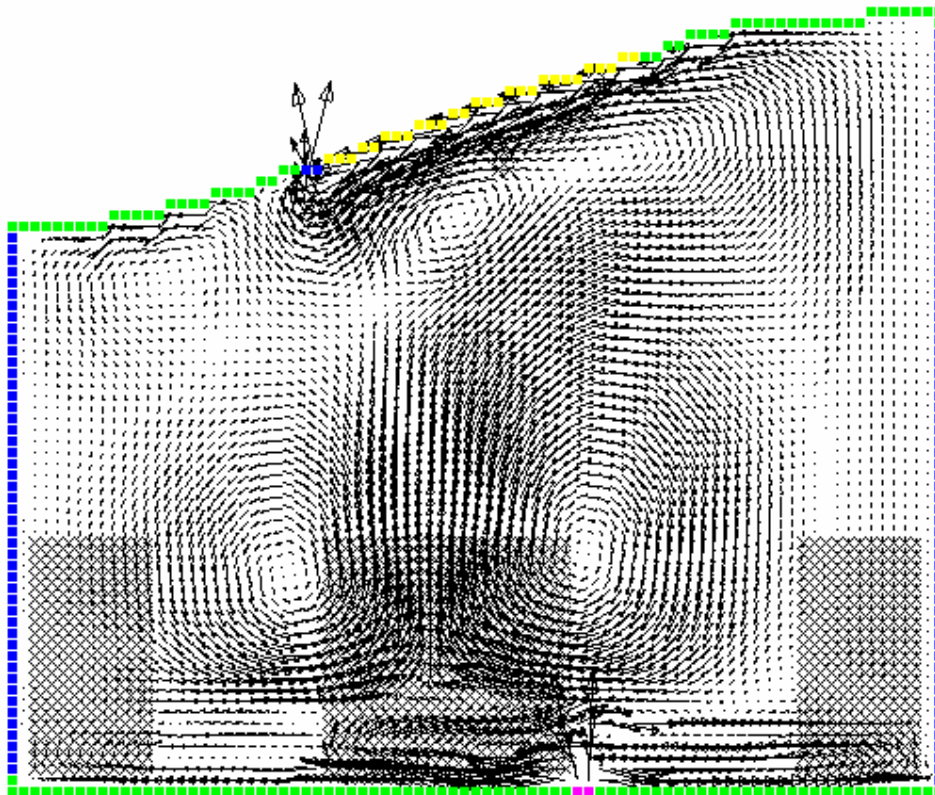

Figure 16: Option 2 Revised Relief Air Outlet Air Flow Pattern

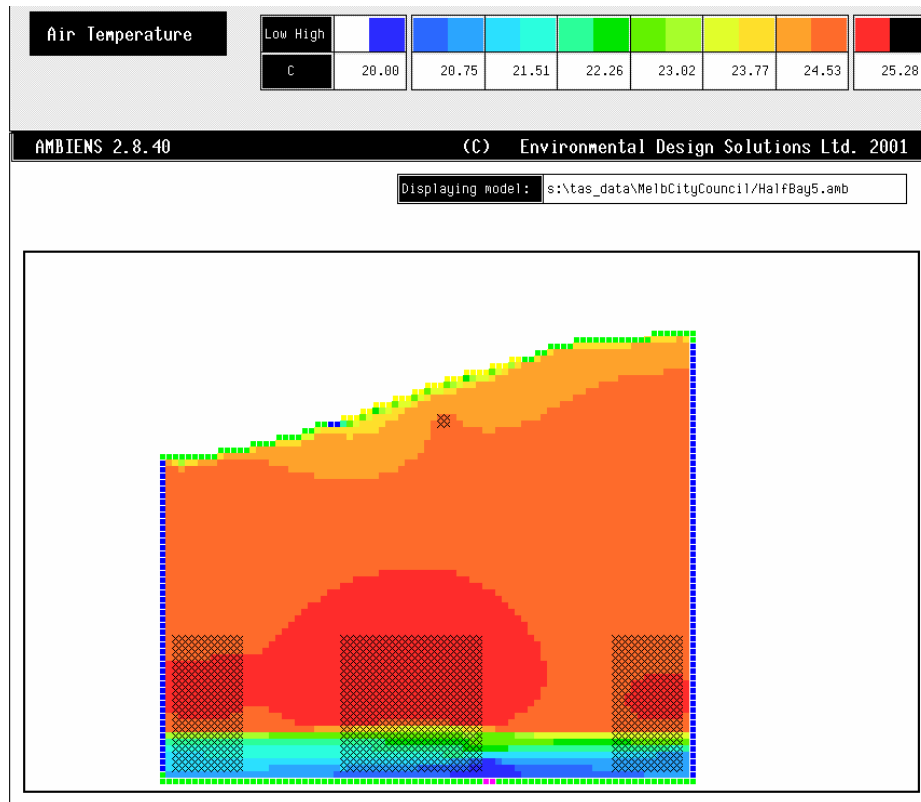

Figure 17: Option 2 Revised Relief Air Outlet Air Temperature

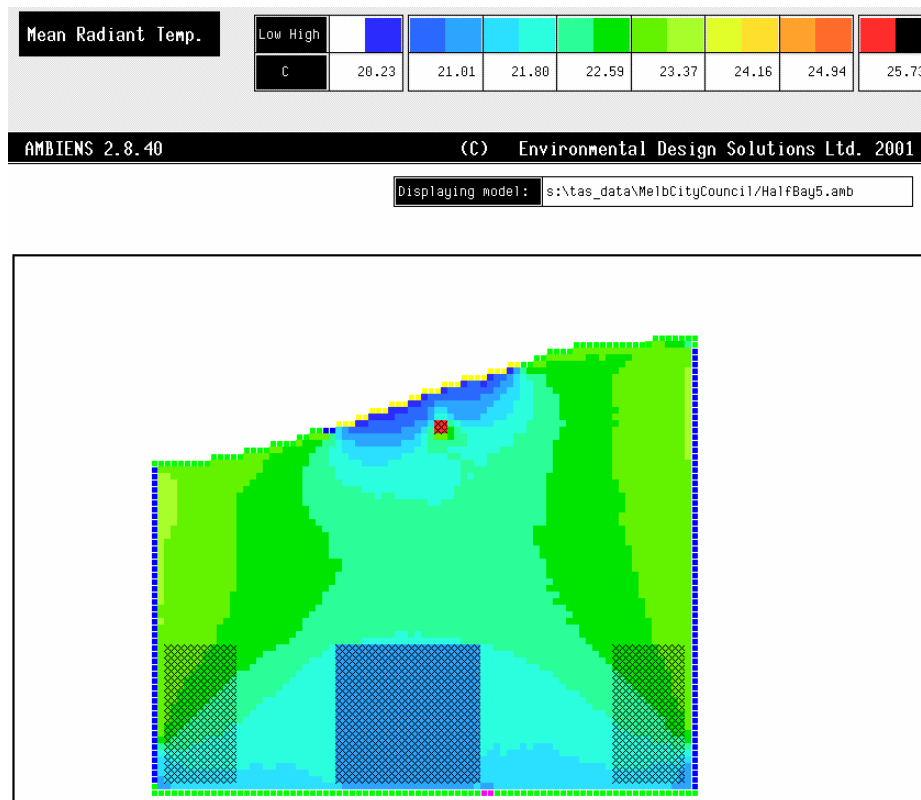

Figure 18: Option 2 Revised Relief Air Outlet Mean Radiant Temperature

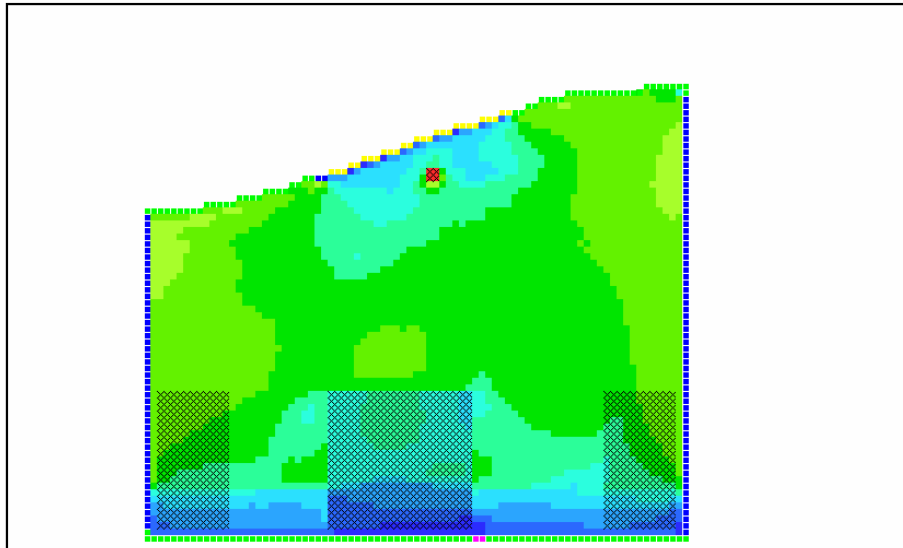
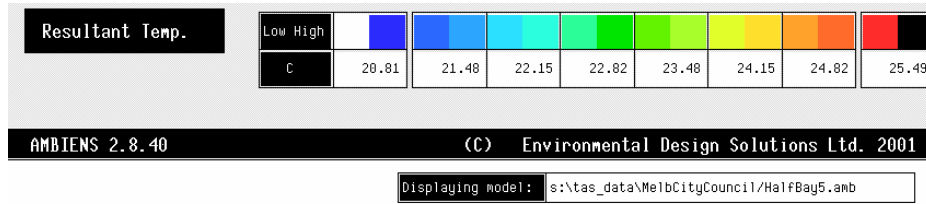

Figure 19: Option 2 Revised Relief Air Outlet Resultant Temperature

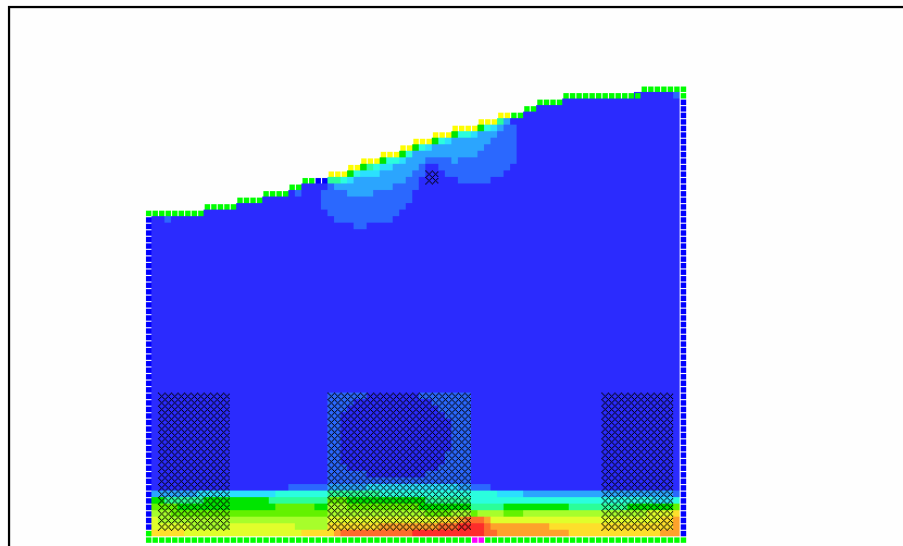
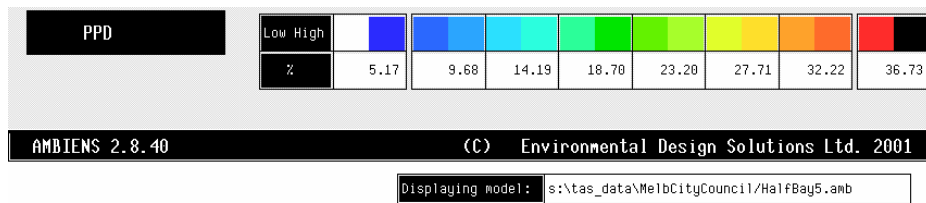

Figure 20: Option 2 Revised Relief Air Outlet PPD